

# Panasonic

## Quick Reference Guide

---

### Digital Proprietary Telephone

Model No. **KX-DT521/KX-DT543/KX-DT546**

### Digital DSS Console

Model No. **KX-DT590**

Thank you for purchasing a Digital Proprietary Telephone (DPT). Please read this manual carefully before using this product and save this manual for future use. For more details, please refer to the manuals of the PBX.

#### **This product supports the following PBX versions and CODEC types:**

- KX-NS300/KX-NS500: PFMPR Software File Version 1.0000 or later
- KX-NS1000: PCMPR Software File Version 3.1000 or later
- KX-NCP500/KX-NCP1000: PBMPR Software File Version 8.0100 or later
- KX-TDE100/KX-TDE200: PMMPR Software File Version 8.0100 or later
- KX-TDE600: PGMPR Software File Version 8.0100 or later
- KX-TDA30: PSMPR Software File Version 5.0100 or later
- KX-TDA50: PSMPR Software File Version 6.0100 or later
- KX-TDA100/KX-TDA200: PMPR Software File Version 5.0100 or later
- KX-TDA600: PLMPR Software File Version 5.0100 or later
- KX-TDA100D: PDMPR Software File Version 5.2000 or later
- CODEC: G.711

#### **Note**

- In this manual, the suffix of each model number is omitted unless necessary.
- The illustrations may differ from the appearance of the actual product.

#### **Trademarks**

- Plantronics is a trademark or registered trademark of Plantronics, Inc.
- All other trademarks identified herein are the property of their respective owners.

# Important Information

### WARNING

Disconnect the telephone line cord from this product if this product emits smoke, an abnormal smell, or makes unusual noise. These conditions can cause fire or electric shock. Confirm that smoke has stopped and contact an authorized service center.

### CAUTION

To prevent damage to the telephone, be sure to unplug the extension line before you set up or remove the KX-DT590 (Digital DSS Console).

---

## For Users in the European Union

### Information for Users on Collection and Disposal of Old Equipment and used Batteries

These symbols on the products, packaging, and/or accompanying documents mean that used electrical and electronic products and batteries should not be mixed with general household waste.

For proper treatment, recovery and recycling of old products and used batteries, please take them to applicable collection points, in accordance with your national legislation and the Directives 2002/96/EC and 2006/66/EC.

By disposing of these products and batteries correctly, you will help to save valuable resources and prevent any potential negative effects on human health and the environment which could otherwise arise from inappropriate waste handling.

For more information about collection and recycling of old products and batteries, please contact your local municipality, your waste disposal service or the point of sale where you purchased the items.

Penalties may be applicable for incorrect disposal of this waste, in accordance with national legislation.



### For business users in the European Union

If you wish to discard electrical and electronic equipment, please contact your dealer or supplier for further information.



### Information on disposal in other countries outside the European Union

These symbols are only valid in the European Union. If you wish to discard these items, please contact your local authorities or dealer and ask for the correct method of disposal.



### Note for the battery symbol (bottom two symbol examples):

This symbol might be used in combination with a chemical symbol. In this case it complies with the requirement set by the Directive for the chemical involved.

### For information of Compliance with EU relevant Regulatory Directives, Contact to Authorized Representative:

Panasonic Testing Center  
Panasonic Marketing Europe GmbH  
Winsbergring 15, 22525 Hamburg, Germany



---

### For Users in Australia and the United Kingdom

- This unit is capable of being used in conjunction with hearing aids fitted with inductive coil pick-ups. The handset should be held as for normal conversation. For operation, the hearing aid should be set to its "T" position or as directed in the operating instructions for the hearing aid.



- This unit is designed to aid the visually handicapped to locate dial keys and buttons.

---

### For Users in the United Kingdom

- This unit is designed to be installed under controlled conditions of ambient temperature and a relative humidity.
- Avoid installing the unit in damp or humid environments, such as bathrooms or swimming pools.
- 999 and 112 can be dialed on the product after accessing the outside line for the purpose of making outgoing calls to the BT emergency (999) and (112) services.

---

### For users in New Zealand

- This equipment shall not be set to make automatic calls to the Telecom '111' Emergency Service.

## ***Important Information***

---

- This device is equipped with pulse dialing while the telecom standard is DTMF tone dialing. There is no guarantee that the Telecom Lines will always continue to support pulse dialing.



### **PTC General Warning**

- The grant of a Telepermit for any item of terminal equipment indicates only that Telecom has accepted that the item complies with minimum conditions for connection to its network. It indicates no endorsement of the product by Telecom, nor does it provide any sort of warranty. Above all, it provides no assurance that any item will work correctly in all respects with another item of Telepermitted equipment of a different make or model, nor does it imply that any product is compatible with all of Telecom's network services.



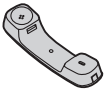

## Accessory Information

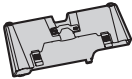
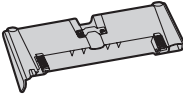
### Included Accessories

#### KX-DT521/KX-DT543/KX-DT546

Handset (1)	Handset Cord (1)	Telephone Line Cord*1
		
<b>Stand (1)</b>		
KX-DT521 	KX-DT543 KX-DT546 	

#### KX-DT590

Stand (1)	Telephone Line Cord (1)*2	Wall mounting adaptor (1)
		
<b>Screws for wall mounting (3)*3</b>		<b>Screws for attaching to the unit (2)</b>
		

\*1 Two cords for the KX-DT521NE/KX-DT543NE/KX-DT546NE. Consult your dealer regarding which telephone line cord to use.

No cords for the KX-DT521NZ/KX-DT543NZ/KX-DT546NZ. Consult your dealer regarding which telephone line cord to use.

One cord for models other than the above.

\*2 For users in New Zealand, consult your dealer regarding which telephone line cord to use.

\*3 Two screws for attaching the KX-DT590 to a wall.

One screw for attaching the wall mounting adaptor to the unit.

## ***Accessory Information***

---

---

### **Optional Accessories**

	<b>KX-DT521</b>	<b>KX-DT543</b>	<b>KX-DT546</b>
<b>Wall mount kit</b>	KX-A432X	KX-A433X	
<b>Digital DSS Console</b>	KX-DT590		

# Location of Controls

KX-DT521NZ/KX-DT521SX/KX-DT521UK/KX-DT521X

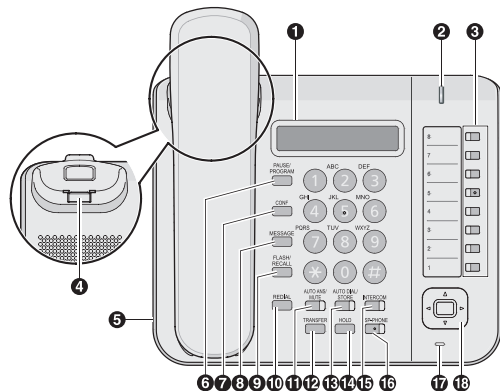

KX-DT521NE

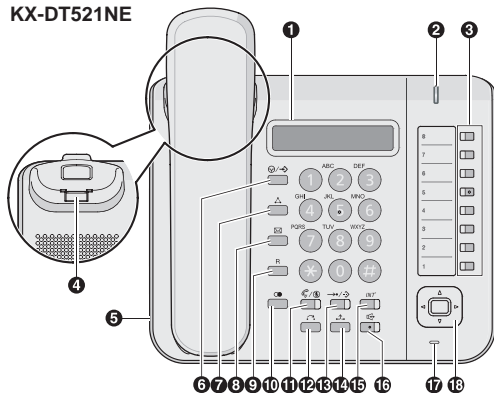

## Location of Controls

KX-DT543AL/KX-DT543NZ/KX-DT543SX/KX-DT543UK/KX-DT543X  
KX-DT546AL/KX-DT546NZ/KX-DT546SX/KX-DT546UK/KX-DT546X

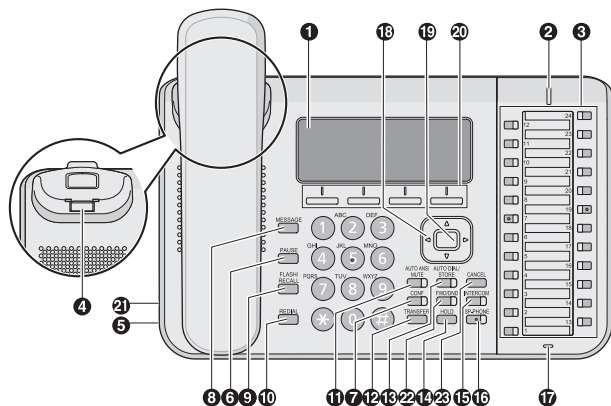



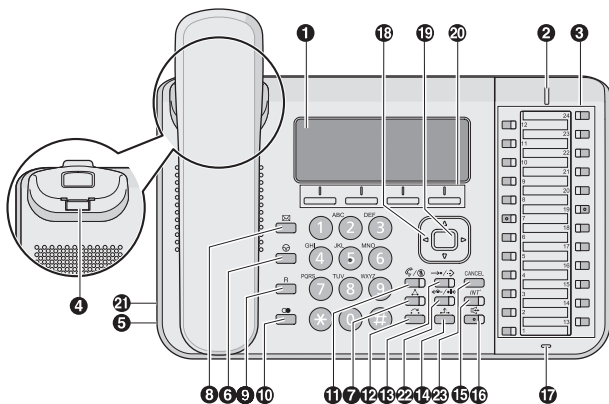



KX-DT543NE/KX-DT546NE

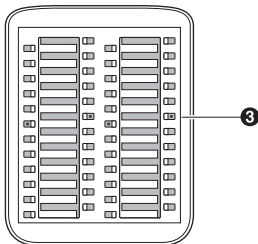









**KX-DT590AL**  
**KX-DT590SX**  
**KX-DT590UK**  
**KX-DT590X**



- 1 LCD (Liquid Crystal Display):**  
 KX-DT521: 1 line, KX-DT543: 3 lines, KX-DT546: 6 lines
- 2 Message/Ringer Lamp:**  
 When you receive an intercom call, the lamp flashes green, and on an outside call, the lamp flashes red. When someone has left you a message, the lamp stays on red.
- 3 Flexible CO Buttons:** Used to seize an outside line or perform a feature that has been assigned to the key.
- 4 Handset Hook:** Keeps the handset stable when the unit is mounted on a wall.
- 5 Headset Jack**
- 6 /→(PAUSE/PROGRAM) (KX-DT521 only):** Used to insert a pause when storing a telephone number. This button is also used for programming this unit.  
** (PAUSE) (KX-DT543/KX-DT546 only):** Used to insert a pause when storing a telephone number.
- 7  (CONF):** Used to establish a multiple party conversation.
- 8  (MESSAGE):** Used to leave a message waiting indication or call back the party who left the message waiting indication.
- 9 R (FLASH/RECALL):** Used to disconnect the current call and make another call without hanging up.
- 10  (REDIAL):** Used to redial the last dialed number.

## Location of Controls

---

- 11  /  (**AUTO ANS/MUTE**): Used to receive an incoming call in hands-free mode or mute the microphone/handset during a conversation.
- 12  (**TRANSFER**): Used to transfer a call to another party.
- 13  (**AUTO DIAL/STORE**): Used for System/Personal Speed Dialing or storing programme changes.
- 14  (**HOLD**): Used to place a call on hold.
- 15 **INT' (INTERCOM)**: Used to make or receive intercom calls.
- 16  (**SP-PHONE [Speakerphone]**): Used for performing hands-free operations.
- 17 **Microphone**: Used for hands free conversations.
- 18 **Navigator Key**: Used to adjust the volume and the display contrast or select desired items.
- 19 **ENTER**\*1: Used to assign the selected item.
- 20 **Soft Buttons (S1-S4)**\*1: S1-S4 (located from left to right) are used to select the item displayed on the bottom line of the display.
- 21 **EHS (Electronics Hook Switch) Jack**\*1
- 22 **FWD/DND**\*1: Used to switch Call Forwarding or Do Not Disturb on your extension.
- 23 **CANCEL**\*1: Used to cancel the selected item.

\*1 KX-DT543/KX-DT546 only

## Before Operating the Telephone

### Speaker volume

While in a hands-free conversation  
Press [▲] or [▼] to adjust the volume.

### Handset/Headset volume\*1

While using the handset or headset  
Press [▲] or [▼] to adjust the volume.

### Ringer volume

While on-hook or receiving a call  
Press [▲] or [▼] to adjust the volume.

### LCD Contrast

While on-hook

1. Press the **PROG** soft button (S1).\*2
2. Enter 0①.
3. Press [ENTER].\*3
4. Press [▲] or [▼] to adjust the LCD contrast.
5. Press [ENTER].\*3
6. Press [CANCEL].\*2

### Ring Tone

1. Press the **PROG** soft button (S1).\*2
2. Press a flexible CO button or *INT'* [INTERCOM] 2 times.
3. Enter 2 digits (01-30) using the dial keys (0-9), or press [▲] or [▼] to select the ring tone.
4. Press [ENTER].\*3
5. Press [CANCEL].\*2

\*1 If you hear your own voice through the handset or headset, decrease the volume.

\*2 For KX-DT521, press 0/→ [PAUSE/PROGRAM].

\*3 For KX-DT521, press →•/→ [AUTO DIAL/STORE].

### LCD Backlight

While on-hook

1. Press the **PROG** soft button (S1).<sup>\*1</sup>
2. Enter ①④.
3. Press [ENTER].<sup>\*2</sup>
4. Press a dial key to select the LCD backlight mode.  
①: Automatic  
①: Always ON  
②: Always OFF
5. Press [ENTER].<sup>\*2</sup>
6. Press [CANCEL].<sup>\*1</sup>

<sup>\*1</sup> For KX-DT521, press  [PAUSE/PROGRAM].

<sup>\*2</sup> For KX-DT521, press  [AUTO DIAL/STORE].

# Feature Operations

## Making Calls

### Calling

#### **[To an extension]**

1. Go off-hook.
2. Dial an extension number.

#### **[To an outside party]**

1. Go off-hook.
2. Press a flexible CO button.
3. Dial the outside party's phone number.

### Redial

1. Go off-hook.
2. Press **●**[REDIAL].

### Quick Dialing

1. Go off-hook.
2. Dial a quick dialing number.

### Doorphone Call

1. Go off-hook.
2. Enter **(\*)3(1)**.
3. Enter a doorphone number (2 digits).
4. After the confirmation tone, talk.

### System Speed Dialing

1. Go off-hook.
2. Press **→•/•↔**[AUTO DIAL/STORE].
3. Enter a system speed dialing number (3 digits).

## Feature Operations

### Personal Speed Dialing

#### **[To store]**

1. Go off-hook.
2. Enter **\*30**.
3. Enter a personal speed dialing number (2 digits).
4. Enter the phone number to store (max. 32 digits).<sup>\*1</sup>
5. Press **#**.
6. After the confirmation tone, go on-hook.

#### **[To dial]**

1. Go off-hook.
2. Press **→•/→**[AUTO DIAL/STORE].
3. Enter **\*3**.
4. Enter a personal speed dialing number (2 digits).

### One-touch Dialing

#### **[To store]**

1. Press the **PROG** soft button (S1).<sup>\*2</sup>
2. Press a flexible CO button.
3. Enter **2**.
4. Enter the number to store (max. 32 digits).<sup>\*1</sup>
5. Press [ENTER].<sup>\*3</sup>
6. Press [CANCEL].<sup>\*2</sup>

#### **[To dial]**

1. Go off-hook.
2. Press the flexible CO button assigned as a One-touch Dialing button.

<sup>\*1</sup> Enter the outside line access number before an outside phone number.

<sup>\*2</sup> For KX-DT521, press **⓪/→**[PAUSE/PROGRAM].

<sup>\*3</sup> For KX-DT521, press **→•/→**[AUTO DIAL/STORE].

## During a Conversation

### Call Hold

#### **[To hold]**

1. Press [HOLD].
2. After the confirmation tone, go on-hook.

#### **[To retrieve a call at the holding extension]**

1. Go off-hook.
2. Press a flexible CO button or *INT'* [INTERCOM].

#### **[To retrieve an outside call from another extension]**

1. Go off-hook.
2. Press a flexible CO button.

### Call Transfer

#### **[To an extension]**

1. Press [TRANSFER].
2. After the confirmation tone, dial an extension number.
3. Talk.
4. Go on-hook.

#### **[To an outside party]**

1. Press [TRANSFER].
2. After the confirmation tone, press a flexible CO button.
3. Dial an outside phone number.
4. Talk.
5. Go on-hook.

### Setting the Telephone According to Your Needs

#### Do Not Disturb

1. Go off-hook.
2. Enter \*7①.
3. Press a dial key to select the setting.  
①: Both outside and intercom calls  
②: Outside calls only  
③: Intercom calls only
4. To enable Do Not Disturb, enter ①.  
To cancel Do Not Disturb, enter ②.
5. After the confirmation tone, go on-hook.

#### Timed Reminder

##### **[To set]**

1. Go off-hook.
2. Enter \*7⑥①.
3. Enter the hour and minute (4 digits).
4. If 12-hour-time display is set, enter ② (AM) or ③ (PM).
5. Enter ④ (1 time) or ⑤ (daily).
6. After the confirmation tone, go on-hook.

##### **[To cancel]**

1. Go off-hook.
2. Enter \*7⑥②.
3. After the confirmation tone, go on-hook.

##### **[To stop or answer the ring back]**

1. Press *INT'* [INTERCOM], or go off-hook.



## Useful Features

### Multiple Party Conversation

#### **[To add other parties during a conversation]**

1. Press  $\Delta$ [CONF].
2. After the confirmation tone, dial the phone number of the party to add.
3. Talk to the new party.
4. Press  $\Delta$ [CONF].
5. After the confirmation tone, talk with multiple parties.

#### **[To leave a conference]**

1. Press  $\Delta$ [CONF].
2. After the confirmation tone, go on-hook.

## Before Leaving Your Desk

### Call Forwarding

1. Go off-hook.
2. Enter  $(*)7(1)$ .
3. Press a dial key to select the types of calls to apply this feature to.
  - ①: Both outside and intercom calls
  - ①: Outside calls only
  - ②: Intercom calls only
4. Press a dial key to select the status.
  - ②: All calls
  - ③: Busy
  - ④: No answer
  - ⑤: Busy/No answer
  - ⑥: Cancel\*1
5. Enter an extension number, and then enter  $(\#)$ , or enter a CO line access number, an outside phone number, and then enter  $(\#)$ .
6. After the confirmation tone, go on-hook.

\*1 If you enter ⑥ in Step 4, you can skip Step 5.

# Installation and Setup

### Note

- Panasonic assumes no responsibility for injuries or property damage resulting from failures arising out of improper installation or operation inconsistent with this documentation.

---

## Attaching a KX-DT590 to the KX-DT543/KX-DT546

The KX-DT590 allows 48 additional Flexible CO buttons to be added to this unit. These buttons are used to seize an outside line, make a call using One-touch Dialing, or perform a feature that has been assigned to the key.



- 1 Attach the KX-DT590 to your unit with the 2 screws.\*1

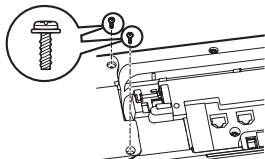

\*1 Included with the KX-DT590.

---

## Attaching the Stand

### KX-DT521

- 1 Insert the catches of the stand into the hooks located in the unit.
- 2 Gently push the stand in the direction indicated until it locks into place. The stand will be mounted.

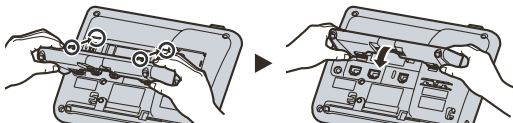

### KX-DT543/KX-DT546/KX-DT590

- 1 Insert the catches (A) of the stand into hooks located in the unit.
- 2 Gently push the stand in the direction indicated until it locks into place. The stand will be mounted in the high position.

**Example: KX-DT546**

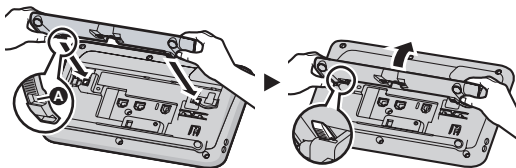

## Removing the Stand

### KX-DT521

- 1 Remove the stand in the direction indicated while pushing the catches of the stand with both hands as shown.

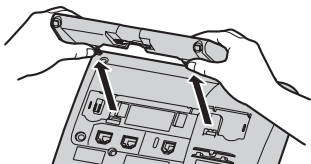

### KX-DT543/KX-DT546/KX-DT590

- 1 Hold the stand with both hands.
- 2 Gently rotate the stand in the direction indicated until it is released.

**Example: KX-DT546**

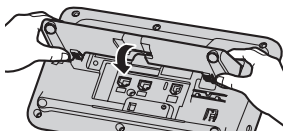

## Connections

### KX-DT521

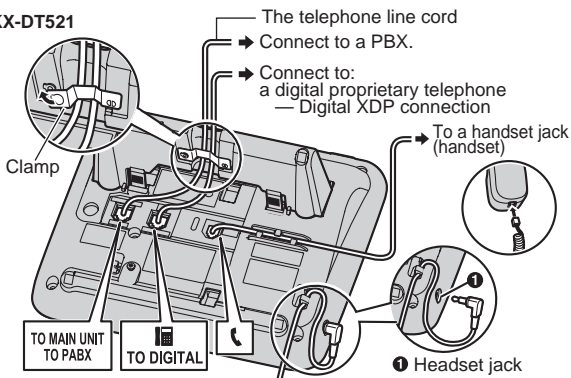

### KX-DT543/KX-DT546

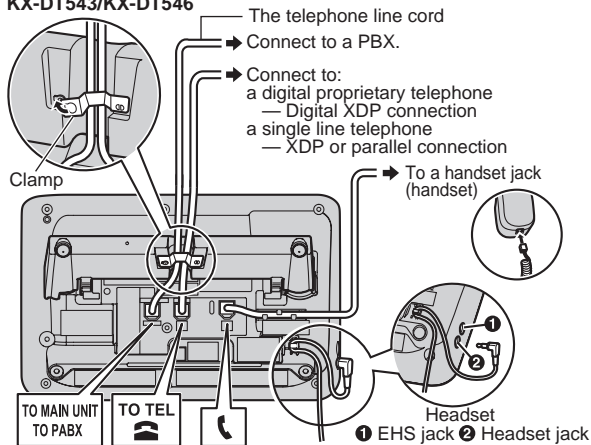

### KX-DT590

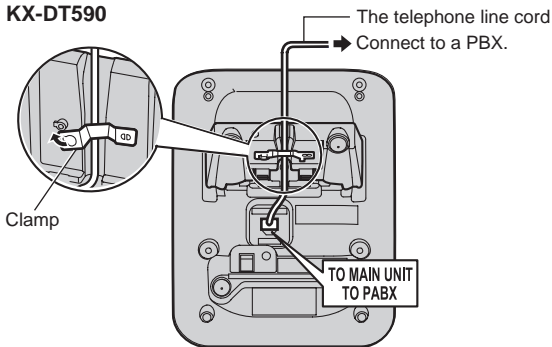

### Note

#### ● When connecting a headset

The following headsets can be used with this unit. (Not all operations with the headsets can be guaranteed.)

##### – Wired headsets

Panasonic RP-TCA400, RP-TCA430, KX-TCA400 or KX-TCA430

##### – EHS headsets (KX-DT543/KX-DT546 only)

Selected Plantronics®-brand headsets

For up-to-date information about headsets that have been tested with this unit, please contact your dealer.

<http://panasonic.net/pcc/support/pbx/>

#### ● When connecting cords

Ensure the cords are inserted in the grooves, and are clamped to prevent damage to the connectors.

# Wall Mounting

### Note

- When mounting the KX-DT543/KX-DT546 with a KX-DT590 on the wall, attach the KX-DT590 to the KX-DT543/KX-DT546 first, and then mount them on the wall. For detail about the attaching, see “Attaching a KX-DT590 to the KX-DT543/KX-DT546”, Page 18.
- When mounting the KX-DT543/KX-DT546 with a KX-DT590 on a wall, only ONE KX-DT590 can be attached.

- 1 Insert the tabs of the wall mounting adaptor into the designated openings in the base, and then slide the wall mounting adaptor in the direction of the arrow until it clicks.

### KX-DT521

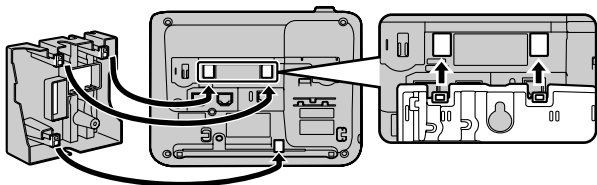

### KX-DT543/KX-DT546 with KX-DT590

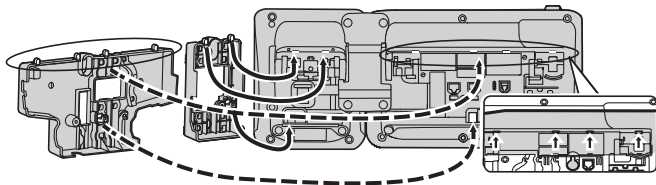

- Fasten the wall mounting adaptor(s) to the base with the screw(s). (Recommended torque: 0.4 N·m [4.08 kgf·cm] to 0.6 N·m [6.12 kgf·cm])
- Connect the cables to the unit, and run the cables through the wall mounting adaptor, as shown in the illustration below.
- Drive the screws into the wall either 83 mm or 100 mm apart, and mount the unit on the wall.

**Example: KX-DT543/KX-DT546 with KX-DT590**

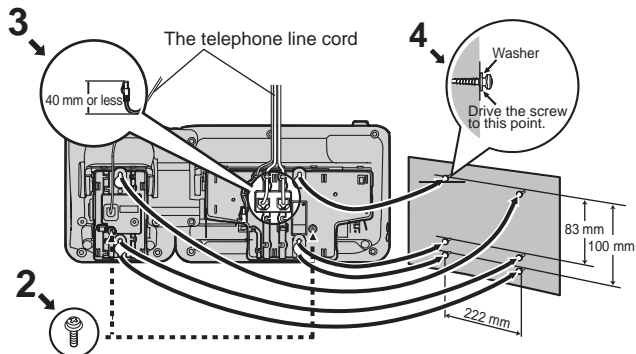

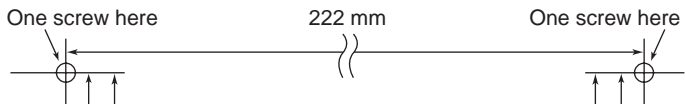

## WALL MOUNTING TEMPLATE

1. Drive the screws into the wall as indicated.
2. Hook the unit onto the screw heads.

### Note:

- If the KX-DT590 is mounted beside a KX-DT543/KX-DT546, leave 222 mm of space between the 2 screws for the DPT and the 2 screws for the KX-DT590, as indicated above. This space is abbreviated in this template and must be measured.

for KX-DT521/KX-DT543/KX-DT546

100 mm  
83 mm

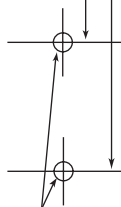

One screw at either point

for KX-DT590  
100 mm  
83 mm

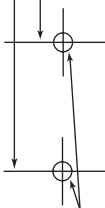

One screw at either point